

SPICE thermal model

BUK7Y7R2-60E

Symbol	Parameter	Conditions	Min	Typ	Max	Unit
$R_{th(j-mb)}$	thermal resistance from junction to mounting base		-	-	0.90	K/W

C_{th1}	5.189E-05 F
C_{th2}	3.399E-04 F
C_{th3}	3.893E-04 F
C_{th4}	2.947E-03 F
C_{th5}	4.944E-03 F
C_{th6}	1.408E-02 F
C_{th7}	1.666E-01 F

R_{th1}	1.612E-03 Ω
R_{th2}	3.276E-03 Ω
R_{th3}	2.283E-02 Ω
R_{th4}	3.326E-02 Ω
R_{th5}	1.806E-01 Ω
R_{th6}	5.956E-01 Ω
R_{th7}	6.723E-02 Ω

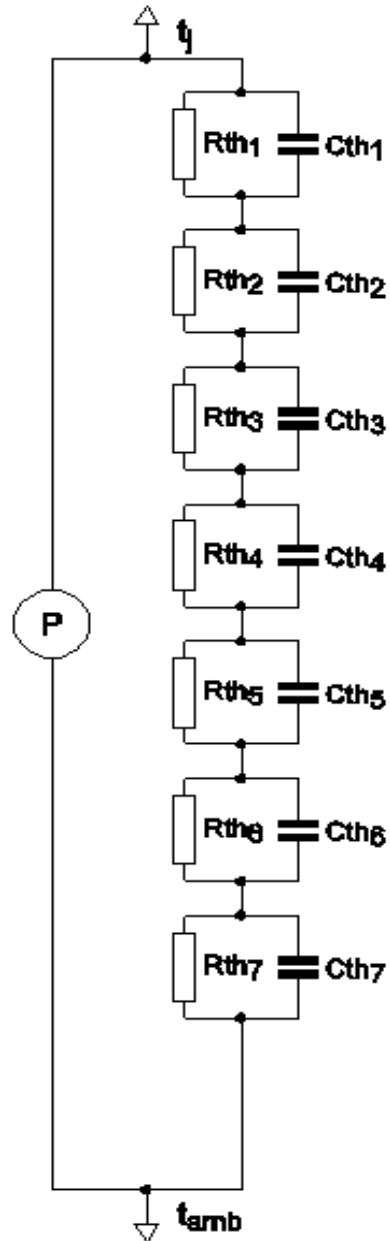

Part: BUK7Y7R2-60E
 Date: 17/4/2013
 Model Rth 0.90 K/W